



EVO Manufacturing
Jeep Wrangler JK/JL and JT Gladiator
JK/JL/JT KSPEC Tube Front Bumper
EVO-3174/B, EVO-3175/B





Before starting installation procedure please read <http://evomfg.com>Returns-Warranties-Shipping>

CAREFULLY READ AND FOLLOW ALL INSTRUCTIONS IN THIS MANUAL AND KEEP FOR FUTURE REFERENCE. IF YOU HAVE ANY QUESTIONS ABOUT THE PRODUCT CALL EVO MANUFACTURING. FAILURE TO FOLLOW GUIDELINES COULD RESULT IN MALFUNCTION OF PARTS OR INJURY. PLEASE HAVE A TRAINED PROFESSIONAL ASSIST WITH OR INSTALL ALL PRODUCTS. INSTALLING EVO MFG PRODUCTS OR KITS DEMANDS SPECIFIC KNOWLEDGE, TOOLS AND EXPERIENCE. GENERAL KNOWLEDGE OF HOW TO USE LATER SPECIFIED TOOLS AND/OR LIMITED EXPERIENCE WITH EVO MFG PRODUCTS MAY NOT BE ENOUGH TO PROPERLY COMPLETE THESE TASKS. SOME OF EVO MFG PRODUCTS MAY REQUIRE TWO OR MORE PEOPLE TO INSTALL SAFELY AND CORRECTLY. DO NOT ATTEMPT ALONE, ALWAYS ENLIST THE HELP OF TRAINED PROFESSIONAL WHEN NEEDED.

Notes: Set Up Before installation

Cutting and grinding will be necessary for this installation.

May need to use a second person to ease install.

Keep all mounting bolts loose (installed but not torqued) we will torque later at the end of complete installation

READ BEFORE INSTALL:

It is generally a good idea to apply Loctite to all threaded bolts.

ALWAYS wear safety glasses and other approved safety gear when working on a vehicle.

All supplied bolts torqued according to chart at end of instruction.

It is recommended all installation be performed by a trained professional. Some modification may have to be done.

Paint all unfinished surfaces after install is complete.

On aluminum bumpers, heat should not be applied due to aluminum properties



Parts included: Table below shows EVO MFG KSPEC Front Bumper.

Description	#	Part #	Part # Black	Part # Bull Bar	Part # Bull Bar Black	Quantity
KSPEC Front Bumper	1	EVO-12577	EVO-12577PC	EVO-12578	EVO-12578PC	1
Skid Plate	2	EVO-12579	EVO-12579	EVO-12579	EVO-12579	1
Hardware Pack	3	EVO-770111	EVO-770111	EVO-770111	EVO-770111	1
Crush Tubes	4	EVO-20055CZ	EVO-20055CZ	EVO-20055CZ	EVO-20055CZ	4

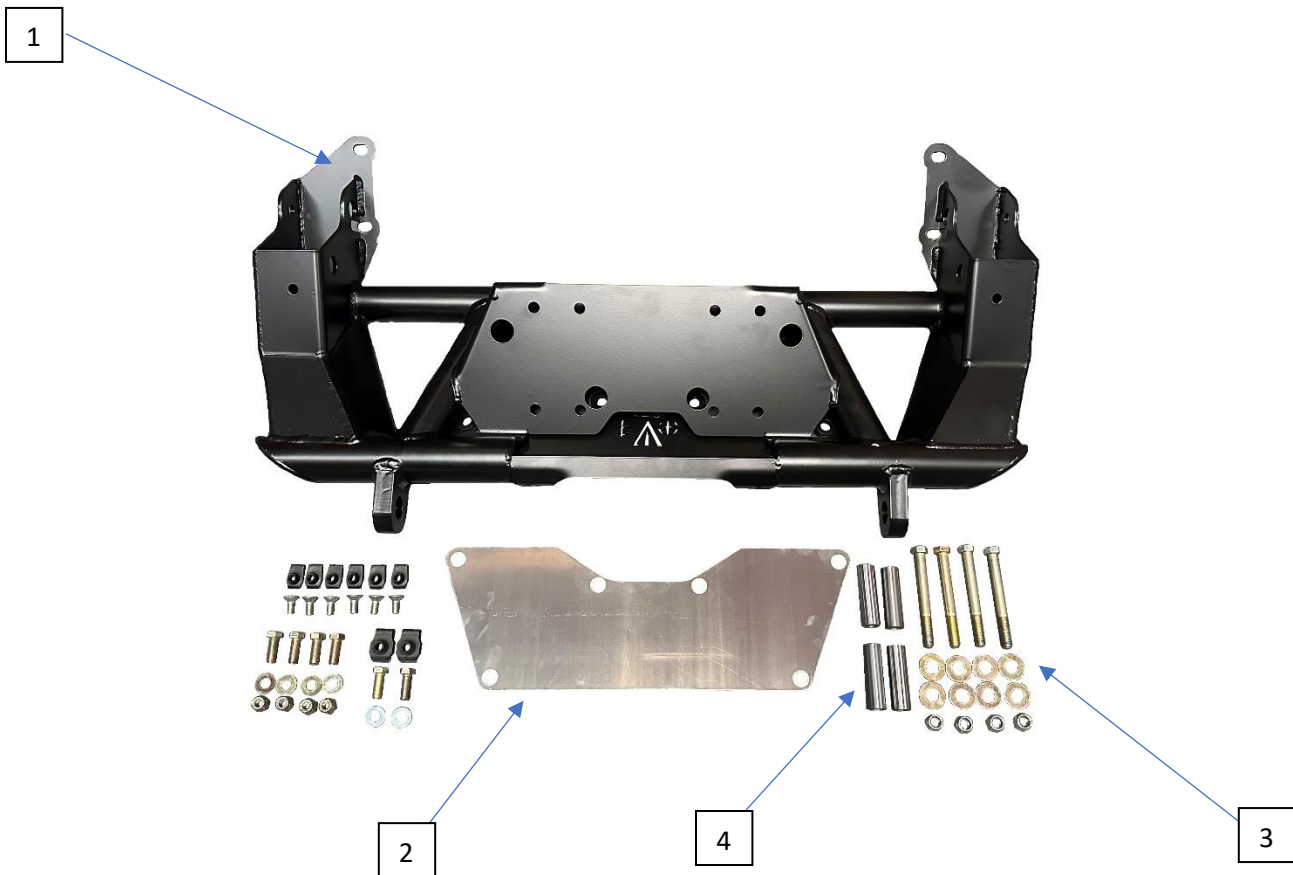



Recommended Tools:

- Allen set / Driver Sockets
 - Impact with sockets
 - Sawzall / Cut off wheel or similar
 - Drill with ½" and ¾" bit / Step bit
-



Safety Steps for installation

- For installing EVO MFG products always use wheel chokes to block rear tires from rolling.
 - Always make sure you have everything necessary ready before install.
 - If you have to, carefully lift front of vehicle by front frame rails extending suspension until tires leave the ground, place frame on approved jack stands for vehicle. Verify all lines/wires are not over extended.
 - Remove tires if needed for easier install.
 - Make sure to wear safety equipment (eye protection, hand protection, foot protection etc.) at all times during installation.
 - Make sure all safety precautions have been taken.
 - Always check and replace any part of vehicle that is worn or broken before starting install.
 - Do not mix anything EVO with weaker alternatives.
 - It is generally a good idea to apply liquid threadlock to all bolts.
 - Tighten included hardware to torque specifications in bottom table unless it is otherwise specified, factory bolts should be torqued to factory Jeep specifications.
-





Various factory bumper options are available. Factory bumper removal steps therefore will vary. This is just a guide, follow factory manual if further instruction is required.

INSTALL:

Safely park car on flat ground, put in park and chock wheels.

1. Remove factory front bumper by removing the 8 nuts on the inside of the bumper and remove the push clips on underside of bumper.
-



2. Remove wires from fog lamps, remove bulbs (if applicable). Reference Jeep manual for removal of bulb, different year and models may vary.
-

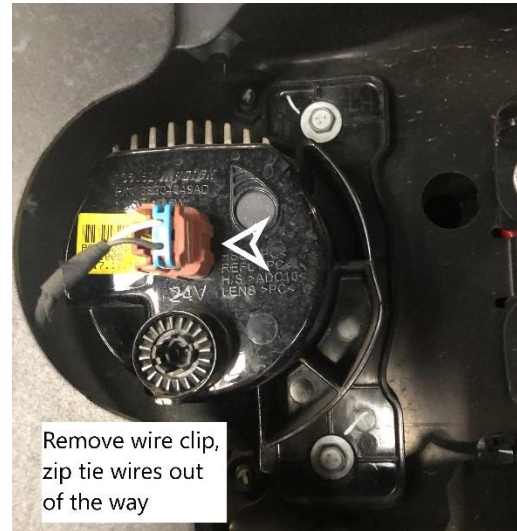

3. For JL and JTs remove the factory frame plates. This will not be reused.
-



4. Remove upper factory plastic in front of grill. Start by removing plastic clips/screws then pull out plastic.
-



5. Remove the four 15mm bolts that hold the sway bar to frame and move the sway bar out of the way.



6. JL/JT ONLY: Mark cut lines as shown. The first cut line should be drawn $\frac{1}{2}$ " from the center of the top hole. The second cut line should be on each of the front body mounts, 2" down from the top of the frame.



JK ONLY: The first cut line should be drawn 1.5" from the center of the top hole. The second cut line should be on each of the front body mounts, 2" down from the top of the frame.

Print the template at the end of instructions and drill holes into the bumper for the sway bar.

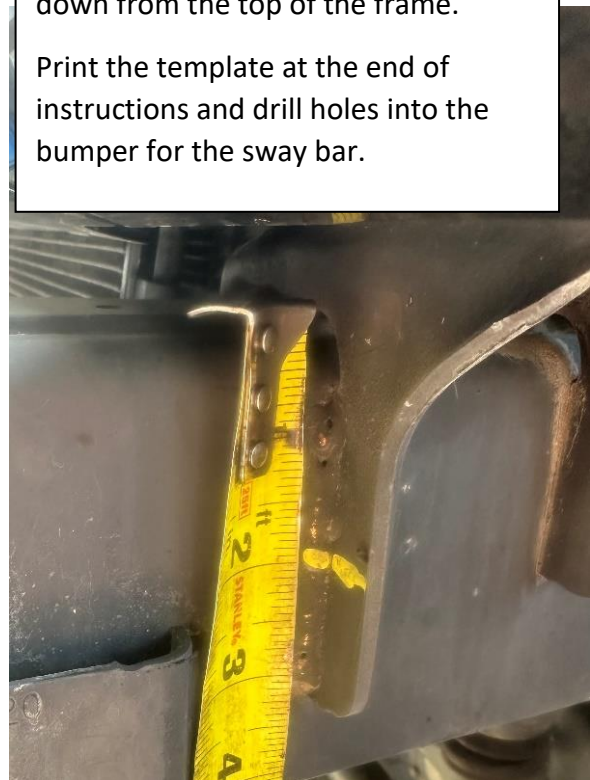



7. Using a Sawzall, cut off wheel or similar, remove / cut the front of the frame using cut lines along with the body mounts.
-

Use proper safety precautions and safety equipment. Make sure no wires or hoses are in the cutting path. Only cut specified area.



8. Remove all brackets apart of the front frame horns as well as the sway bar mounting brackets.
-



9. Grind / sand down frame rails so bumper can slide on.



10. JL/JT ONLY: Grind / sand down the sway bar bushings so they are flat with the brackets



11. JL/JT ONLY: Drill out the top hole in the frame with a 1/2" bit.

12. Install the 3/8" barrel nuts onto the top of the frame.



13. JL/JT ONLY: Mount the bumper onto the frame and use the top hole to locate the bumper on the frame. Mark the side holes on the inside and outside of the frame that need to be drilled. 8 in total.

JK ONLY: Mount the bumper onto the frame and use the sway bar bolts to locate the bumper on the frame. Mark the side holes on the inside and outside of the frame that need to be drilled. 8 in total.



14. Remove the bumper and drill the 8 side holes that were marked in the previous step with a 1/2" drill on the outside of the frame and a 3/4" drill bit on the inside of the frame.



15. Paint all exposed metal to prevent corrosion.

16. Before the final install of the bumper, install the six 5/16" barrel nuts onto the bumper to mount the skid plate. Proper alignment of the barrel nuts are required for the skid plate to sit flush. Fine tuning of barrel nut placement and grinding to edges of barrel nuts may be required and should be done now.

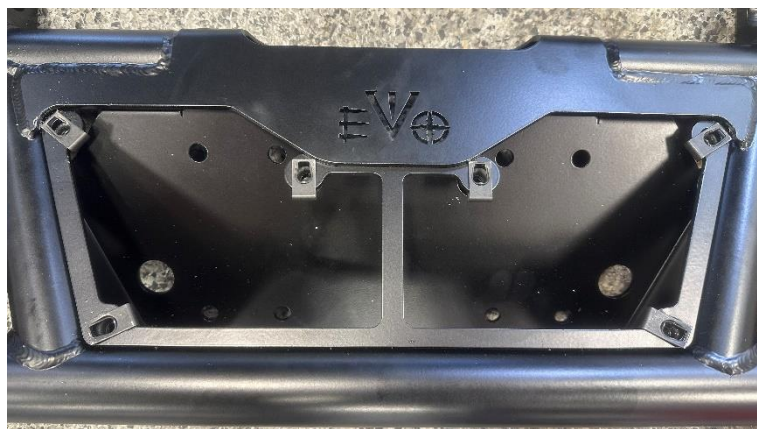



17. Install the bumper. Insert the crush tubes from the inside of the frame and install the four 7/16" x 4" bolts and 7/16" Nylock nuts with washers through the side of the frame with a 5/8" socket and wrench. It is optional to install the two 3/8" x 1" fasteners with washers into the top of the frame. They are only necessary for locating the bumper. Torque to the recommended torque specs on the last page.



For installing winch:

If a winch is to be installed. Follow the directions that came with your winch and mount to the outer 4 bolt pattern on the bumper. The EVO MFG KSPEC bumper will accept center mount winches as well as competition winches.



18. After installing the winch (if applicable), install the six 5/16" flat head cap screws to mount the skid plate to the bumper.

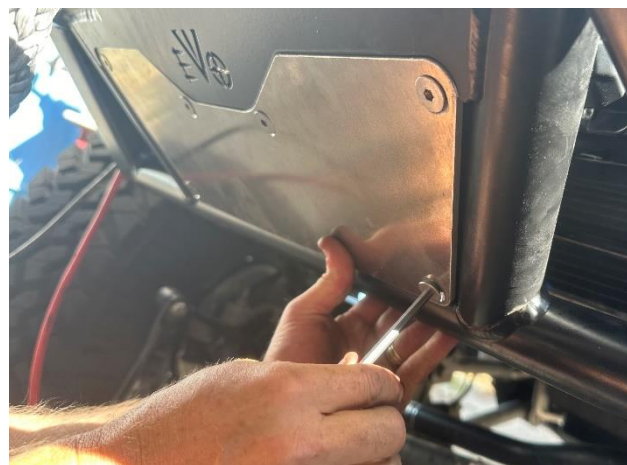



19. JL/JT ONLY: Install the four M10 bolts and Nylock nuts with washers to mount the sway bar to the bumper with a 17mm socket and wrench. If continuing to do the optional Rubicon saw bar mount relocation, leave hardware loosely installed.

JK ONLY: 2012+ models need the vacuum pump to be relocated use part EVO-1096. Re-install the sway bar using the factory sway bar bolts. If continuing to do the optional Rubicon saw bar mount relocation, leave hardware loosely installed.



Optional Rubicon electronic sway bar mount relocation:

20. Remove bolt from the front mount of the sway bar motor. (long bolt that goes through the rubber isolator)

21. The motor will now freely rotate on the axis of the sway bar.

22. Rotate the sway bar motor forward as much as possible.

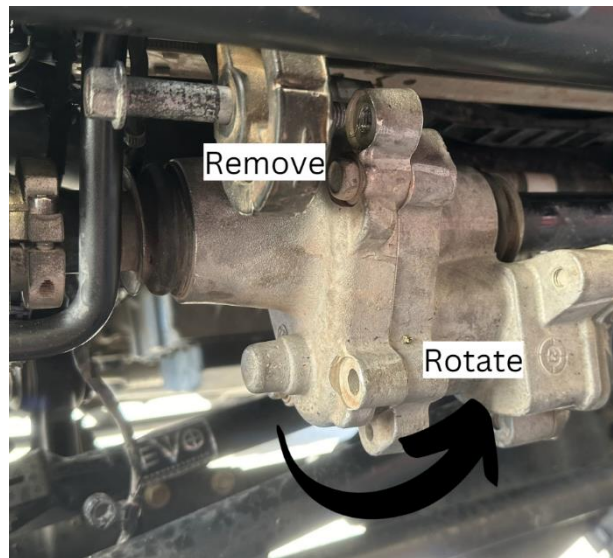

23. With a ½" diameter drill, mark off ¾" from tip down on the drill with tape.



24. In the new mounting hole, drill from the passenger side toward the center of the vehicle ¾" deep (up to tape mark) into new mounting hole. DO NOT DRILL MORE THAN ¾".

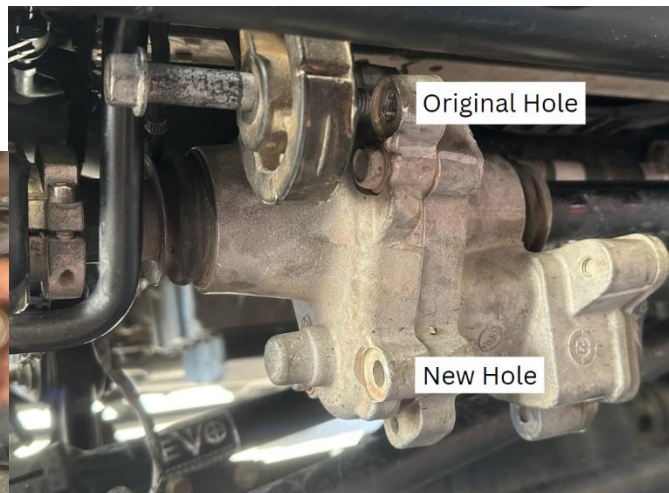

25. Using the same bolt removed earlier install through the factory rubber isolator and into the newly drilled hole. Tighten all sway bar bolts.

After Install:

- Tighten all bolts securing purchased parts to specified locations.
- After completing installation using provided instructions, go through all steps again to make sure nothing was missed, not tightened or improperly assembled.
- Some components may need to be purchased separately.
- Check turn signals, headlights, fog lights (if applicable), taillights, blinkers and windshield wipers.
- Adjust mirrors, speedometer and headlights if needed.
- Make sure all gauges are fully operational.
- Drive the vehicle slowly for a couple minutes, looking and listening for abnormal noises while driving. After modification of a vehicle there will be differences in driving experiences and capabilities, be mindful of that.
- Inspect and Retorque all Bolts after 500 miles of completed installation and regularly thereafter.
- Some modification may be required.



Recommended Torque:

Size	Grade 2		Grade 5		Grade 8		18-8 S/S	
	Coarse	Fine	Coarse	Fine	Coarse	Fine	Coarse	Fine
#4*	-	-	-	-	-	-	5.2	-
#6*	-	-	-	-	-	-	9.6	-
#8*	-	-	-	-	-	-	19.8	-
#10*	-	-	-	-	-	-	22.8	31.7
1/4	4	4.7	6.3	7.3	9	10	6.3	7.8
5/16	8	9	13	14	18	20	11	11.8
3/8	15	17	23	26	33	37	20	22
7/16	24	27	37	41	52	58	31	33
1/2	37	41	57	64	80	90	43	45
9/16	53	59	82	91	115	129	57	63
5/8	73	83	112	128	159	180	93	104
3/4	125	138	200	223	282	315	128	124
7/8	129	144	322	355	454	501	194	193
1†	188	210	483	541	682	764	287	289

JK Sway Bar Hole Drill Template

Print 1:1 or at 100%

Use shown dimension to verify for scale
Drill both slotted holes marked with the X

